

Article number: 12728000020120

Description: KLEE-coil 728 000 020.120
M2 Steel, zinc-pl. & chr. yellow

Measures

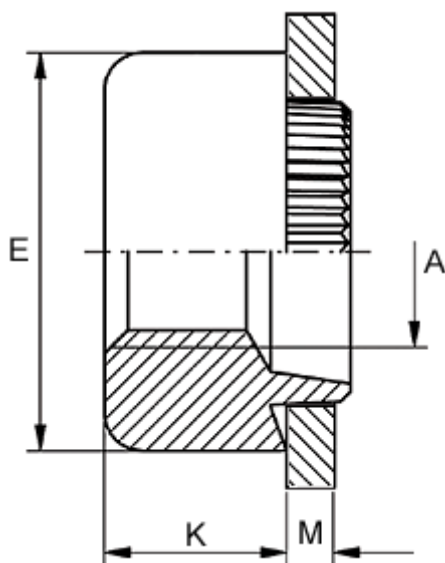

Female thread A	= M2
Height K	= 2.0
Outer diameter E	= 5.0
Plate thickness	= 2.0 to 2.2
Recommended bore diameter +0.05	= 4.0